



A New Scope Plug-In for Convenient Measuring of Fast Switching Times

THE increased speed of transistors and diodes has brought about a need for a convenient and rapid means of determining the performance of these devices. Consequently, a new plug-in for the -hp- 185A/B Sampling Oscilloscope has been designed which will measure the time performance of a variety

SEE ALSO:
Kilomegacycle Scope, p. 4
Automatic Switching-Time Measurements, p. 6

of fast semiconductor devices and will do so in a very convenient manner. To be capable of making such measurements, the new plug-in constitutes a complete test system and provides all of the signals and viewing equipment needed for a measurement. Specifically, the plug-in includes:

- (a) a pulse generator with a fast rise time of less than 1 nanosecond (millimicrosecond),
- (b) a vertical display system with an overall rise time of a fraction of a nanosecond,

- (c) a set of adjustable dc supplies to power the device under test, and
- (d) a set of convenient and versatile test circuits into which the device under test can be connected for measurement.

In addition to being usable for measuring the properties and basic parameters of semiconductor devices, the plug-in can be used to determine the pulse response of networks and circuits. Any circuit that can be characterized by its step or pulse response can be evaluated with this unit. In many cases the use of time-domain techniques can replace conventional frequency-domain techniques and can provide a more convenient method of observing circuit performance. Linear amplifiers, blocking oscillators, counter circuits, and transmission line systems can all be easily evaluated in the time domain using the new plug-in.

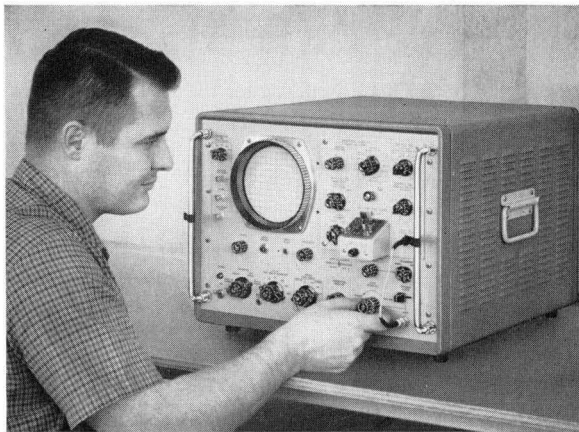

Fig. 1. New -hp- Model 186A Switching Time Tester plug-in operates with -hp- Model 185A or 185B Sampling Oscilloscope to measure rise, fall, switching, and recovery times of fast transistors, diodes, tunnel diodes. Device to be tested simply plugs into test circuit provided on holder. Tester provides fast test pulse and adjustable voltages for operating device.

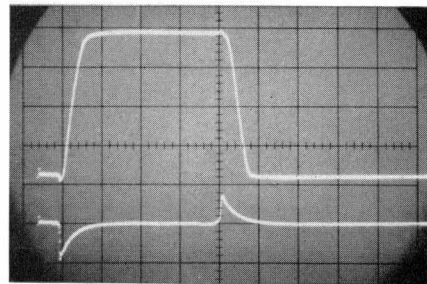

Fig. 2. Oscillogram of transistor response (upper trace) showing typical information obtainable with new Tester. Delay, rise, storage, and fall time data can be determined. Lower trace shows time of leading and trailing edge of test pulse. Oscillogram was made by dual exposure since Tester display consists of one trace; see text. Sweep time here is 50 nanoseconds/cm.

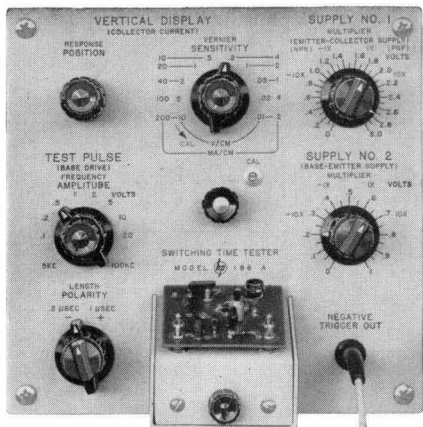

Fig. 3. Panel detail of new -hp-186A Tester. Holder has test transistor plugged into test circuit on card.

The pulse generator contained in the plug-in provides an output of 0.1 volt to 20 volts into a 50-ohm load with a rise time of less than 1 nanosecond. Two pre-set pulse widths of 0.2 and 1 microsecond of either polarity are provided, although these can also be adjusted internally to lie between 0.15 microsecond and 1.1 microsecond. The pulse repetition rate is variable from 5 kc to 100 kc, the lower rates being useful when needed to stay within the dissipation limitations of the device under test.

The overall vertical display system of the plug-in and oscilloscope is a single-channel system with a rise time of less than 0.45 nanosecond. The sensitivity is variable from 10 millivolts/cm to 10 volts/cm and has a vernier which increases the sensitivity of each step by a factor of 3. The input impedance is 50 ohms, so the vertical sensitivity expressed in terms of input current is 0.2 ma/cm to 200 ma/cm.

Although the input impedance of the vertical display channel is 50

ohms, the unit can be used for circuit probing by using resistive divider probes.

Two independent power supplies are included in the plug-in to supply the circuit or device under test. One supply is variable from -30 to +30 volts and the other from -10 to +10 volts. The second supply can be referenced either to ground or the first supply.

TRANSISTOR TEST CARD

The test circuits which are provided with the plug-in as an easy means of operating the device under test are arranged to connect to the plug-in with the circuit holder shown in Fig. 4. The test circuits are supplied in the form of cards which can be plugged into the holder. Three circuit cards are provided in addition to one special card for viewing the test pulse itself. Fig. 5 shows the test circuit provided for measuring the pulse response of a transistor, and Fig. 2 shows an oscillogram of the pulse response of a typical high-speed switching transistor as tested in this circuit. The typically-specified switching parameters such as delay time, rise time, storage time, and fall time can be determined from the oscillogram. Using these measuring times, the various "charge control" parameters can be computed. The time of the leading and trailing edge of the drive pulse is indicated on the lower trace of Fig. 2. The lower trace was obtained by removing the transistor from the test circuit and closing switch S_1 shown in Fig. 5.

The circuit of Fig. 5 can also be used to obtain a rough plot of the transistor current gain vs. frequency.

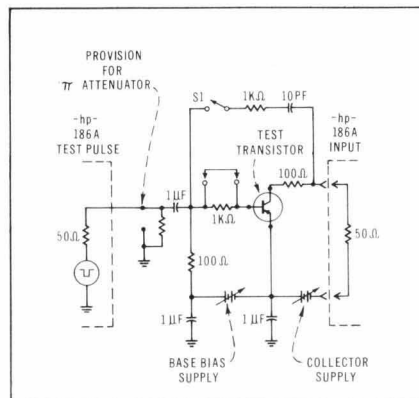

Fig. 5. Transistor test circuit provided on plug-in test card. Other values can easily be inserted.

With the transistor biased in the conducting region, a small base-drive pulse is used and the collector current is observed on the oscilloscope (Fig. 7(a)). Using a single-pole approximation for the transistor, the plot of current gain vs. frequency is obtained (Fig. 6). The frequency at which the current gain is unity (f_T) can be computed by the following relationship:

$$f_t = \frac{.35}{t_r} \cdot \frac{\Delta I_2}{\Delta I_1}$$

t_r = rise time
 ΔI_2 = change in collector current
 ΔI_1 = change in base current.

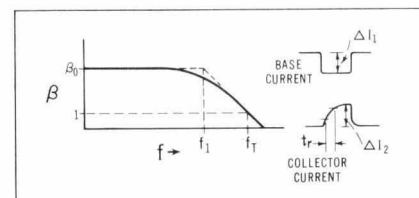

Fig. 6. Plot indicating how transistor test yields frequency characteristic.

DIODE TEST CARD

Another of the plug-in circuit cards is designed for observing the recovery time of diodes. The circuit

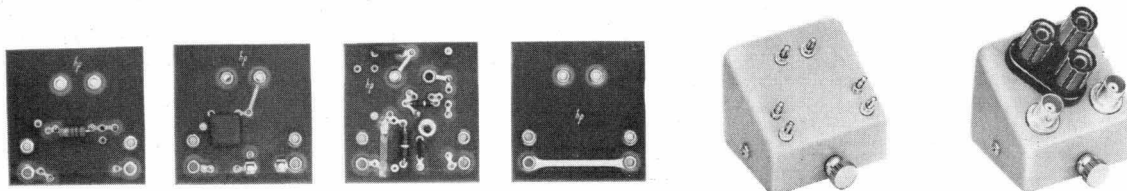
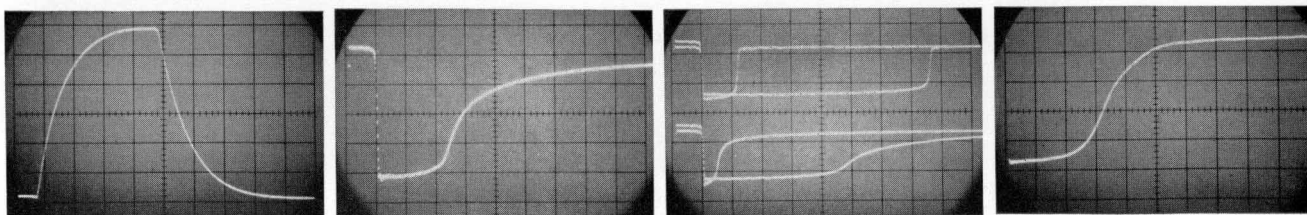

Fig. 4. Test circuit cards and holders provided with Tester. Circuits of cards are shown in other illustrations. Right-hand card permits viewing test pulse.



(a) Transistor collector current. Sweep time is 50 nsec/cm. (b) Diode recovery characteristic. Sweep time is 10 nsec/cm. (c) Diode recovery (four exposures; see text). Sweep is 10 nsec/cm. (d) Tunnel diode transition waveform. Sweep is 1 nsec/cm.

Fig. 7. Oscillograms of various device characteristics as observed with new Tester and discussed in text.

of the card is shown in Fig. 8, and a typical diode recovery characteristic as measured with the card is shown in Fig. 7(b). Various forward and reverse currents can be applied to simulate the circuit conditions of many diode applications.

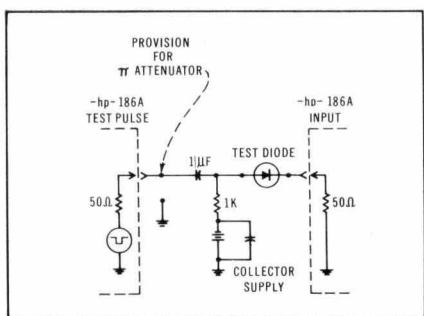

Fig. 8. Diode test circuit provided on plug-in test card.

The reverse recovery waveform of a diode consists of two phases: a constant reverse-current phase and a transition phase. The duration of the reverse constant-current phase is the time required for the excess carrier density at the diode junction to become zero. The transition phase duration is determined by the gradient of doping at the junction. Fig. 7(c) shows the reverse recovery of an abrupt junction and a graded junction for two different values of forward current. Notice the short second phase for the graded junction diode. It is this rapid transition that characterizes the "Boff" or "step recovery" diodes, and makes them useful for the generation of fast pulses.

The rate of recombination of excess carriers determines the property called lifetime. This is the time required for the stored charge to decay to $1/e$ of its initial value. The stored

charge is related to lifetime and forward current by the following equation:

$$Q_s = \tau I_f (1 - e^{-t_f/\tau})$$

The storage time is related to the lifetime by the following equation:

$$\tau = \frac{t_s}{\ln [1 + I_f (1 - e^{-t_f/\tau})] I_r}$$

If $t_f \gg \tau$ and $\frac{I_f}{I_r} = 1.7$, then $\tau = t_s$.

- τ = lifetime
- t_s = storage time
- t_f = time forward current is flowing
- I_f = forward current
- I_r = reverse current
- Q_s = stored charge

TUNNEL DIODE TEST CARD

Another circuit card (Fig. 9) is provided for observing the switching time of tunnel diodes. The test pulse is converted to an exponentially-increasing current to drive the diode under test. The diode current increases until it reaches I_f and then the diode switches to the next stable

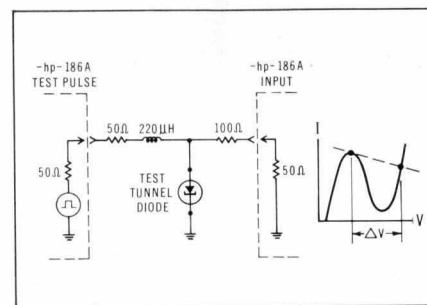

Fig. 9. Tunnel diode test circuit provided. Typical tunnel diode characteristic shown at right.

point on its characteristic curve (Fig. 9). The time required for this transition is obtained by observing the diode voltage with the Tester, as shown in the oscillogram of Fig. 7(d).

The design of the Model 186A plug-in was joint effort of several members of the research and development department of the -hp- Oscilloscope Division. Other members of the design group included George Blinn, Charles Lundeen, and Ken Marshall.

—Kay B. Magleby

SPECIFICATIONS

-hp-

MODEL 186A SWITCHING TIME TESTER

(As plugged into -hp- 185A/B Sampling Oscilloscope)

TEST PULSE PROVIDED:

- Amplitude: 0.1 volt to 20 volts peak in a 1, 2, 5 sequence; either polarity.
- Rise time: Less than 1 nsec.
- Width: 0.2 μsec or 1 μsec as selected by panel switch; each setting also internally adjustable from approx. 0.15 to 1.1 μsec.
- Fall time: Less than 3 nsec.
- Repetition rate: Approx. 5 kc to 100 kc; continuously variable.
- Trigger out: Triggers the -hp- 185 Oscilloscope approx. 120 nsec. in advance of pulse output.

DISPLAY SYSTEM:

- Sensitivity: 10 mv/cm to 10 v/cm in a 1, 2, 5 sequence; vernier provides continuous adjustment between steps and increases maximum sensitivity to 3 mv/cm.
- Bandwidth: dc to 800 mc (0.45 nsec rise time).
- Noise: Less than 3 mv.

BIAS SUPPLIES PROVIDED:

- Collector supply: 0 to ±30 v, 50 ma maximum (0.5 amp with 10% duty cycle).
- Base supply: 0 to ±10 v, referable either to ground or to the collector voltage; 20 ma maximum (0.2 amp with 10% duty cycle).

TEST CIRCUITS SUPPLIED:

- Transistor, diode, tunnel diode, and shorting circuits supplied (see text); circuit holder and universal adapter also supplied.

GENERAL:

- Power: Provided by -hp- 185A/B Oscilloscope.
- Weight: Approx. 5 lbs.

PRICE:

- \$1500.00 f.o.b. factory.
- Data subject to change without notice.

THE KILOMEGACYCLE SAMPLING OSCILLOSCOPE

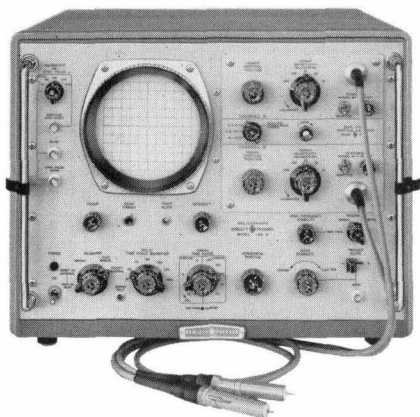

Fig. 1. -hp- Model 185B Sampling Oscilloscope with dual-channel Model 187B 1 kmc plug-in.

TWO years ago the Hewlett-Packard laboratories developed a general-purpose oscilloscope which had the special property that its frequency response extended up to hundreds of megacycles. The oscilloscope was based on a technique called the sampling technique which enabled the instrument to have not only a very wide bandwidth but a high sensitivity as well. Since its introduction, this oscilloscope has come to be an indispensable tool for high-frequency and fast-circuit work. Its general convenience has brought to the nanosecond area oscilloscope techniques that were previously possible only in microsecond and slower circuits.

Over a period of time even the high performance of the original sampling oscilloscope has been advanced until the present instrument (Fig. 1) has a response extending to 1 kilomegacycle. The sensitivity of the instrument extends to 4 millivolts/cm, which at the other extreme can be attenuated to 200 mv/cm with a calibrated control. This range of sensitivities is combined with a vertical display that is 10 cm high, thus giving the instrument the capability of handling large signals of 2 volts as well as small signals. A divider increases the large-signal capacity by 10 times when desired.

Besides the foregoing properties, the oscilloscope has a high impedance and one that exists at the probe input where it is available for practical use. The input resistance is 100 kilohms, while the input capacity is but 2 picofarads.

The oscilloscope has the additional convenience that the above characteristics are all incorporated in each channel of a dual-channel input, permitting simultaneous comparison of two fast phenomena. Further, these characteristics are determined by a vertical plug-in, giving the oscilloscope considerable additional flexibility, since another plug-in is available to measure fast switching times (see p. 1).

EXTENDED TIME SCALES

Although the sampling oscilloscope is mainly used with fast or high-frequency signals, it is not re-

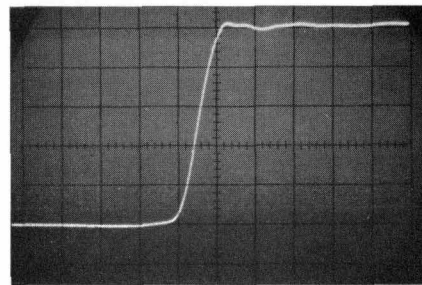
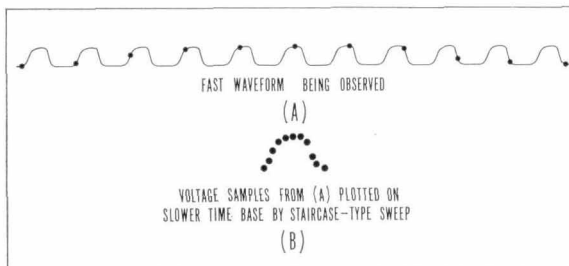

Fig. 2. Step response typical of Model 187B plug-in. Sweep is 0.5 nsec/cm.

stricted to such work, since its low-frequency response extends down to dc. Fast work, too, has its slower aspects in that it is often desirable in such work to be able to view all or a portion of a train of fast pulses or to view the slower signals that occur with some fast signals. To facilitate such usage, additional slow time scales have been incorporated into the oscilloscope. The slowest time scale at present is 10 microseconds/

PRINCIPLES OF THE SAMPLING TECHNIQUE

The sampling oscilloscope is a general-purpose oscilloscope which is used like other oscilloscopes but which operates on a somewhat different principle. In short, the sampling oscilloscope is the electrical analog of the optical stroboscope used in mechanical applications. It differs from conventional oscilloscopes in that, instead of continuously monitoring the waveform to be observed, it obtains samples of the waveform amplitude at discrete points along the waveform. Each sample is taken on a different occurrence of the input waveform at progressively later and later points, as indicated in the accompanying drawing. As they are taken, the samples are plotted as amplitude on the vertical axis of the crt. At the same time the crt horizontal axis is driven by a stepped signal which plots the progression of the amplitude samples through the waveform, thereby forming the time axis. The resulting display is thus a composite, one that is made up of a number of samples, each from a different occurrence of the waveform.



The great bandwidth and high sensitivity of the sampling oscilloscope result from the fact that the sampling circuitry is located immediately at the oscilloscope input. Amplification and display thus take place on samples rather than on the fast input waveform itself. These operations can then be carried out in the several-microsecond interval between samples instead of in the nanosecond interval of the fast waveform. Normally, the latter interval is the interval that conventional oscilloscopes are required to operate in. The rise time of a sampling oscilloscope is determined by the sampler and is approximately the time width of the sample. At present it is much easier to obtain a sample of fractional-nanosecond width than to amplify and display with this speed.



Fig. 3. -hp-185B/187B Oscilloscope with Model 1100 Delay Line (lower unit) for use if measured circuit does not provide trigger.

cm, giving the instrument a maximum-width time window of 100 microseconds for a 10-cm sweep or a full cycle of a 10 kc repetition-rate signal.

The time calibration of the oscilloscope is determined by the combined setting of the *Time Scale* and the *Time Scale Magnifier* controls. These have an overall time scale range of from 10 microseconds/cm to 0.1 nanosecond/cm in a 1, 2, 5 sequence. In this instrument magnification has the distinction that it in no way reduces the brightness, accuracy, or resolution of the display. Any point on the unmagnified time scale can be chosen for magnification with the *Delay* control.

TRIGGER SENSITIVITY AND SPEED

In the design of conventional oscilloscopes it is customary to delay the signal being viewed before displaying it in order to allow for the delay that occurs in the trigger and sweep circuits. In a sampling oscilloscope, however, this delay would have to precede the normal input point, thereby giving the oscilloscope the low impedance of a delay line as its input impedance rather than the high impedance that has been achieved in the sampling probe. Therefore, provision is made for the main signal delay, if re-

quired, to be achieved through the use of a separate, external delay line which is available as an accessory, as shown in Fig. 3. This arrangement permits the high impedance of the oscilloscope to be preserved for general work and for the cases where the circuit under test will supply a trigger that is in advance of the signal to be viewed.

Triggering places demanding requirements on an oscilloscope of this frequency range, since the instrument must be capable of triggering from very narrow pulses of low amplitude and from signals of ultra-high frequency. To meet these requirements, the oscilloscope uses a tunnel diode in the triggering circuit. For frequencies up to 100 megacycles, the diode is operated as a triggered element, while for frequencies from 100 to 1,000 megacycles the diode is operated as an oscillator which locks to the viewed frequency at a submultiple in the vicinity of 10 mc. This synchronized submultiple is then passed to the normal trigger circuits. The *High Frequency Stability* control adjusts the diode oscillator frequency to the vicinity of a submultiple of the input frequency to achieve a stable lock. Fig. 4 shows the stability with which the oscilloscope can synchronize on a 1,000 mc signal. The synchronizing or countdown circuit is also available in an external, battery-operated package for use with the earlier Model 185A oscilloscope.

X-Y RECORDING

A feature of the sampling oscilloscope that has been useful for making large, accurate reproductions of a viewed waveform is the recording feature. This is such that voltages are provided at the back of the instrument to operate an X-Y recorder and thereby reproduce the display from the oscilloscope on paper. A *Record* position on the *Scanning* control causes the display to be scanned slowly in the increasing time direction at constant velocity.

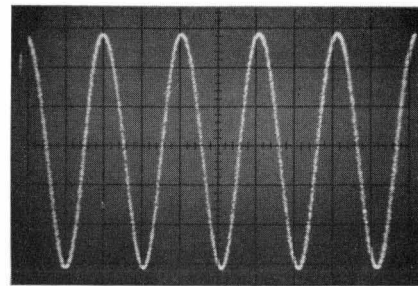

Fig. 4. Oscillogram of 1 kilomegacycle signal indicates stability of Model 185B synchronizing.

The scan requires about one minute to cross the screen and is thus compatible with external recorders. Manual scanning is also provided for. In this case the scanning progresses under the control of the *Manual Scan* knob.

PRACTICAL CIRCUIT CONNECTION

In work at the high frequencies at which the sampling oscilloscope operates, the method of connecting an oscilloscope probe to the circuit under test is of the utmost importance to avoid circuit disturbance and waveform distortion. Broad experience in the application of the

(Continued on page 8)

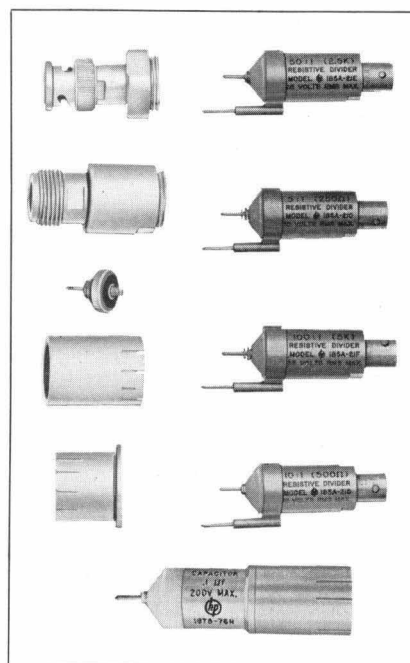

Fig. 5. A number of adapters and accessories permit connecting to fast waveforms with minimum circuit disturbance.

A DIGITAL SYSTEM FOR AUTOMATIC MEASUREMENTS OF SWITCHING TIMES

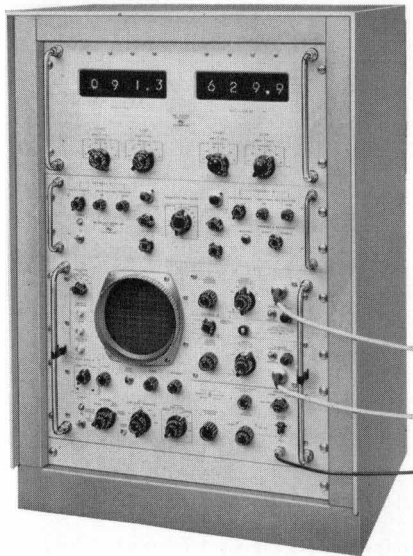

Fig. 1. Dymec Automatic Waveform Measuring System makes rapid time-interval measurements, such as switching times of high-speed transistors and diodes.

THE Dymec DY-5844C Automatic Waveform Measuring System furnishes a versatile means for evaluating time-interval measurements such as transistor delay, rise, storage and fall times as well as measuring the reverse recovery time of semiconductor diodes. Two time-interval measurements are made simultaneously with the basic system and the results are displayed on decimal readouts. Auxiliary equipment provides for additional simultaneous time-interval measurements and enables the automatic technique to be extended to waveform area measurements, as used in evaluations of diode and transistor stored charge or magnetic core switching flux, and to automatic pulse amplitude measurements. Other standard Dymec equipment provides for tolerance (go-no go) comparisons and recording.

A need for accurate, fast measurements of performance parameters has arisen because of the trend toward insuring equipment reliability by 100% inspection of components prior to assembly. Hewlett-Packard's

Dymec Division developed the DY-5844C System, incorporating an -hp-185B Sampling Oscilloscope (described elsewhere in this issue), modified to fill this need. The system reads the time interval between two selected points on a test waveform, dual registers permitting pairs of these measurements to be made and displayed simultaneously. The system also supplies the measurement data in binary-coded-decimal form for operating printers or card and tape punches. System accuracy is high, time intervals being measured to $\pm 3\%$ of the measurement. Other quantities are measured with comparable precision.

SYSTEM OPERATION

The Dymec equipment counts the number of sample pulses occurring between points of interest on the reconstructed waveform displayed by the 185B. Since samples represent uniformly spaced increments on the oscilloscope's timebase, the number of samples between selected points is proportional to the time interval between corresponding points on the actual waveform. Time interval measurements can be made with high resolution at any equivalent real-time speed of the oscilloscope since scan density of the modified 185B is independent of time scale, every 10-centimeter trace having 10,000 samples.

The points which mark the measurement intervals on the waveform may be defined as voltage level crossings, such as the point where the

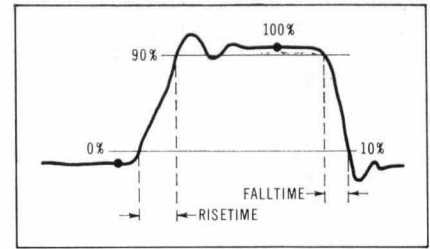

Fig. 2. Typical application of -dy- 5844C System. Intensified dots show where 0% and 100% levels are set. For rise time measurement, System starts count when waveform crosses 10% level, stops at 90% level.

waveform voltage reaches a selected percentage of full amplitude, or in terms of a voltage selected with respect to some reference.

REFERENCE STORAGE AND NORMALIZATION

A key function performed by the DY-5844C system is "normalizing" or automatic determination and storage of reference voltages. This function continuously provides voltages which represent the 0% and 100% voltage levels of the waveform on each channel. From these two voltages, intermediate percentage levels, such as the 10%, 50% and 90% levels, are derived in precision resistive dividers. These voltages are redetermined during each sweep of the scope, normally at a ten per second rate, so that the measurement is independent of any d-c (vertical) drift in the circuit under measurement. In addition, measurements related to percentage of pulse amplitude remain accurate despite changes in pulse amplitude because of this con-

Fig. 3. Dual Register unit selects regions to be evaluated, displays results.

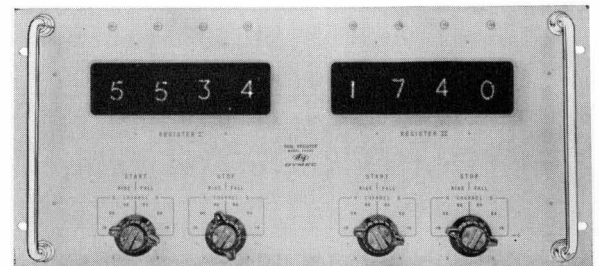

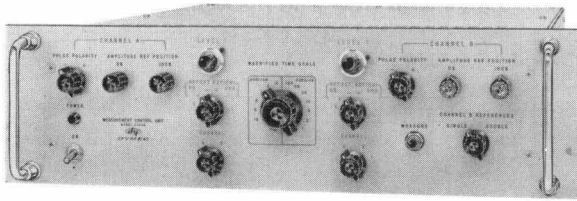

Fig. 4. Measurement Control Unit sets 0% and 100% references and controls measurement cycle.

tinuous correction. A floating input voltmeter, such as the Dymec DY-2401A, may be connected across the 0% and 100% voltage outputs to read pulse amplitude automatically.

The 0% and 100% levels may be determined at any selected points on the waveforms. This permits these reference levels to be determined on flat parts of the waveforms removed from any transient ringing or noise, as shown in Figs. 2 and 6. The reference positions are independently adjustable on both oscilloscope channels by means of front-panel controls on the Measurement Control Unit (see Fig. 4). The adjustment is made only once, prior to a series of measurements on similar components or circuits, and no further adjustment is required.

A third pair of reference voltages may be derived in the B channel. As shown in Fig. 6, this "double samp-

ling" mode prevents inaccuracies in measurement caused by feedthrough from the driving pulse to the response pulse, which can occur in some test circuits.

Measurements requiring start and/or stop points in terms of voltage or current offset from a reference value, such as those encountered in diode reverse recovery time and direct-coupled logic circuit evaluation, can be made with the use of two ten-turn potentiometers included in the Measurement Control Unit. Switching allows these controls to indicate centimeters of oscilloscope deflection from the stored 0% level or an adjustable percentage of waveform amplitude.

THE MEASUREMENT CYCLE

With the oscilloscope probes connected into the circuit under test, the measurement cycle is initiated

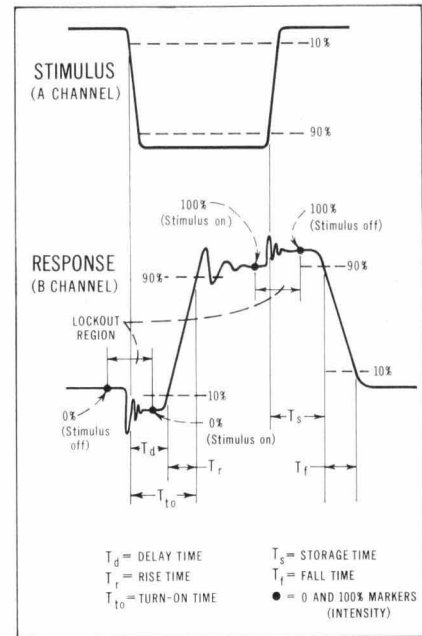

Fig. 6. Typical transistor measurements performed by -dy- 5844C System.

by pressing the front-panel push-button switch on the Measurement Control Unit (this action also may be initiated by closure of a pair of contacts at a remote location). One complete pass of the reconstructed waveform establishes the 0% and 100% levels on both channels. Actual measurement of the waveform occurs within the next pass. Each pass is 100 milliseconds in duration.

Time interval measurements can be referenced to rising or falling portions of waveforms on either the A or B channel. Fixed percentage trigger levels of 10%, 50%, and 90% on either channel may be selected by front-panel switches on each register. In addition, the register accumulation may be stopped or started on other percentage values or offset voltages according to the setting of the variable controls (1 and 2) on the Measurement Control Unit. For instance, the rise time of a pulse on Channel B may be measured by selecting Channel B for Register I and setting the START switch to 10%, RISE. The STOP switch of the same register is set to 90%, RISE, and again Channel B is selected. The system then measures the time interval

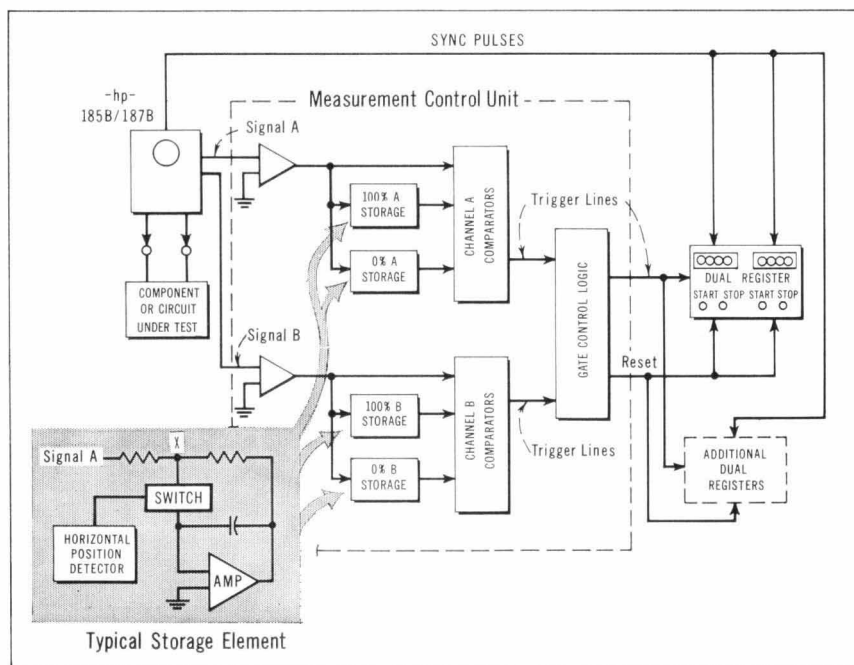

Fig. 5. Block diagram of -dy- 5844C System. Storage unit uses high-gain (10^7) operational amplifier to achieve high linearity.

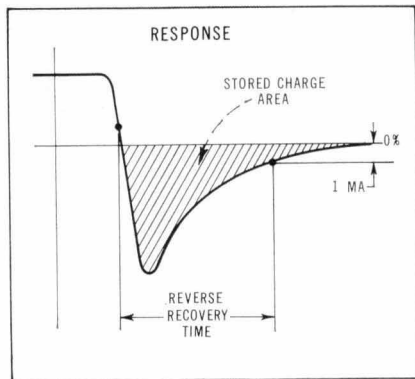

Fig. 7. To obtain evaluation of test-diode stored charge, -dy- 5844C can be used with -dy- Integrating Digital Voltmeter to measure recovery area.

between the 10% and 90% points on the positive-going waveform in Channel B. Turn-on delay of a transistor, whose stimulus pulse appears on Channel A and whose output pulse appears on Channel B, may be measured simultaneously by setting the Register II START switches to Channel A, 10%, RISE and the STOP switches to Channel B, 10%, RISE. Other measurements, such as pulse width, fall time, and storage time, are made simply by selecting the appropriate start and stop combinations.

(Continued from page 5)
sampling oscilloscope has resulted in the design of a variety of adapters and accessories which provide for convenient and practical connection to the test circuit. These devices are

ACKNOWLEDGMENT

The design and development of the DY-5844 was performed by John Humphries, L. R. Summers, R. S. Adam, C. C. Riggins and W. P.

Nilsson of Dymec. Notable support was provided by B. M. Oliver, G. F. Frederick and A. R. Carlson of Hewlett-Packard.

—H. C. Stansch

BRIEF SPECIFICATIONS DY-5844C AUTOMATIC WAVEFORM MEASURING SYSTEM

(Note: All specifications of the standard -hp- 185BR Sampling Oscilloscope and -hp- 187B Dual Trace Amplifier are retained. Specifications given below are pertinent to the DY-5844C System.)

INPUTS:

Dual Channel: Separate channels for stimulus and response pulses. Cables and probes furnished.
Input Impedance: 100K shunted by 2 pf. (1M shunted by 2 pf using 10:1 Divider.)
Bandwidth: DC to 1000 mc, with rise time of less than 0.4 nsec.
Sensitivity: Calibrated ranges from 10 mv/cm to 200 mv/cm. Accessory 10:1 Divider for ranges to 2 v/cm.

TIME INTERVAL RANGES:

13 ranges from 10 nsec to 100 μ sec full scale.

ACCURACY (Time Interval)

Overall System Accuracy: Measurement accuracy under normal operating conditions is within $\pm 3\%$ of reading $\pm 0.2\%$ of full scale for 24-hour day.

RESOLUTION:

At least 1 part in 2,000 for equivalent 10 cm oscilloscope horizontal deflection and scan density of 1000 dots/cm. (Alternative scan density of 100 dots/cm may be selected for low pulse repetition rates in the region 500 to 5000 cps.)

ELECTRICAL OUTPUTS:

Parameters in 4-2'-2-1 code, range, stored references, and signal waveform.

EXTERNAL TRIGGER INPUT:

± 150 mv to ± 2 v peak for 5 nsec or longer (50 ohm input impedance). Trigger rate

from 500 cps to at least 100 mc for sweep speeds of 200 nsec/cm and above.

MEASUREMENT INITIATION:

System measurements may be initiated by front panel pushbutton or external contact closure (applied to connector on Measurement Control Unit).

MEASUREMENT RATE:

All parameters measured simultaneously in approx. 350 millisecc.

FEATURES AVAILABLE:

The following are typical of features available as standard options.

- Measurement of four, six or more time intervals.
- Coupler for parallel-entry recorders.
- Coupler for serial-entry recorders.
- Go/no-go checking: 3 most significant digits of each measured time interval compared against manually-selected upper and lower tolerance limits. Hi/Go/Lo lamp indications and contact closures provided.
- Pulse amplitude measurement.
- Pulse area measurement.
- Pulse Generator and Fixture.
- Power supplies for component or circuit under test.

PRICE:

Basic DY-5844C Automatic Waveform Measuring System (for simultaneous measurement of two time intervals); includes oscilloscope, Dual Register, and Measurement Control Unit, all for rack mount: \$9,575.00.

DYMEC

A division of Hewlett-Packard Co.
395 Page Mill Road
Palo Alto, California

All prices f.o.b. Palo Alto, California
Data subject to change without notice.

shown in the accompanying illustrations.

DESIGN TEAM

The design group for the sampling oscilloscope with its plug-ins

and accessories has included Allan Best, Richard Clark, Ben Helms, Arthur Johnston, Kay Magleby, Kenneth Marshall, Richard Monnier and the undersigned.

—Roderick Carlson

BRIEF SPECIFICATIONS -hp- MODEL 187B DUAL TRACE AMPLIFIER

(When plugged into Model 185B Oscilloscope)
VERTICAL (Dual Channel)

Bandwidth: (a) DC to 800 mc, less than 0.5 nsec rise time for any input signal. (b) For most signals, a pass band of dc to 1000 mc and a rise time of less than 0.4 nsec may be obtained by adjustment of the "response" control. The required conditions for such operation are that the waveform be identical from occurrence to occurrence and the rise time be displayed by at least 12 samples.

Overshoot or Undershoot: Less than 5%.

Sensitivity: Calibrated ranges from 10 mv/cm to 200 mv/cm in 1, 2, 5 sequence. Vernier control provides continuous adjustment between ranges and increases maximum sensitivity to 4 mv/cm.

Noise: Approximately 2 mv peak-to-peak, reduced by approximately 5:1 in smoothed (noise-compensation) position of response switch.

Input Impedance: 100K shunted by 2 pf, nominal.

Accessories Furnished: 187A-76A BNC Adapter, 2 supplied. 187B-76F Probe Adapter, 2 supplied. 187B-21A-11 Probe Sleeve, 2 supplied.

Price: -hp- Model 187B Trace Vertical Amplifier, \$1,000.00.

-hp- MODEL 185B OSCILLOSCOPE

HORIZONTAL:

Magnification: 7 calibrated ranges X1, X2, X5, X10, X20, X50 and X100. Increases maximum calibrated sweep speed to 0.1 nsec/cm; with vernier, maximum sweep speed is further extended to 0.04 nsec/cm. Intensity and sample density are not affected by magnification.

Delay Control: Three-turn variable delay control is available when using magnified sweep. Permits any portion of unmagnified trace to be viewed on screen.

Sample Density: Continuously adjustable from approximately 70 samples per trace to 1000 samples per trace.

CALIBRATOR:

Voltage: 20 mv, 100 mv, 200 mv and 1000 mv; $\pm 3\%$.

Time: Approximately 5 μ sec burst of 50 mc sine wave. Frequency accuracy $\pm 2\%$.

X-Y RECORDER OUTPUT:

X- and Y-axis signals are available at rear terminals in all positions of the Scanning Control. In the MANUAL and RECORD positions the voltage can be used to make pen recordings with a conventional X-Y recorder.

GENERAL:

Cathode Ray Tube: 5AQ mono-accelerator crt with P2 phosphor. Other phosphors are optional.

Internal Graticule (Standard): Graticule in same plane as phosphor eliminates parallax. 10 cm x 10 cm, major axes have 2 mm subdivisions.

Accessories Furnished: 185B-21A Sync Probe. Price: -hp- Model 185B Oscilloscope with internal graticule crt, \$2,300.00. Also available with external graticule and filter compatible with crt, no extra charge. -hp- Model 185B Dual Trace Vertical Amplifier, \$1,000.00.

Prices f.o.b. factory

Data subject to change without notice